

TS-SF-BL34(43)15-20

SFP BIDI 155M 1310/1490nm(1490/1310nm) 20KM Transceiver

PRODUCT FEATURES

- Up to 155Mb/s data links
- FP laser transmitter
- PIN photo-detector.
- Up to 20km on 9/125 μ m SMF
- Hot-pluggable SFP footprint
- BIDI LC/UPC type pluggable optical interface
- Low power dissipation
- Metal enclosure, for lower EMI
- RoHS compliant and lead-free
- Single +3.3V power supply
- Compliant with SFF-8472
- Case operating temperature

Commercial: 0 $^{\circ}$ C to +70 $^{\circ}$ C

Extended: -10 $^{\circ}$ C to +80 $^{\circ}$ C

Industrial: -40 $^{\circ}$ C to +85 $^{\circ}$ C

APPLICATIONS

- Switch to Switch Interface
- Fast Ethernet
- Switched Backplane Applications
- Router/Server Interface
- Other Optical Links

PRODUCT DESCRIPTION

TRANSCOM's TS-SF-BL34(43)15-20 Small Form Factor Pluggable (SFP) transceivers are compatible with the Small Form Factor Pluggable Multi-Sourcing Agreement (MSA). The transceiver consists of four sections: the LD driver, the limiting amplifier, the FP laser and the PIN photo-detector. The module data link up to 20KM in 9/125um single mode fiber.

The optical output can be disabled by a TTL logic high-level input of Tx Disable, and the system also can disable the module via I2C. Tx Fault is provided to indicate that degradation of the laser. Loss of signal (LOS) output is provided to indicate the loss of an input optical signal of receiver or the link status with partner. The system can also get the LOS (or Link)/Disable/Fault information via I2C register access.

Ordering information

Product part Number	Data Rate (Mbps)	Media	Wavelength (nm)	Transmission Distance(km)	Temperature Range(Tcase) (°C)	
TS-SF-BL34(43)15-20	155	Single mode fiber	1310/1490(1490/1310)	20	0~70	commercial
TS-SF-BL34(43)15-20E	155	Single mode fiber	1310/1490(1490/1310)	20	-10~80	extended
TS-SF-BL34(43)15-20A	155	Single mode fiber	1310/1490(1490/1310)	20	-40~85	industrial

I .Pin Descriptions

Pin	Symbol	Name/Description	Ref.
1	V _{EET}	Transmitter Ground (Common with Receiver Ground)	1
2	T _{FAULT}	Transmitter Fault.	
3	T _{DIS}	Transmitter Disable. Laser output disabled on high or open.	2
4	MOD_DEF(2)	Module Definition 2. Data line for Serial ID.	3
5	MOD_DEF(1)	Module Definition 1. Clock line for Serial ID.	3
6	MOD_DEF(0)	Module Definition 0. Grounded within the module.	3
7	Rate Select	No connection required	4
8	LOS	Loss of Signal indication. Logic 0 indicates normal operation.	5
9	V _{EER}	Receiver Ground (Common with Transmitter Ground)	1
10	V _{EER}	Receiver Ground (Common with Transmitter Ground)	1
11	V _{EER}	Receiver Ground (Common with Transmitter Ground)	1
12	RD-	Receiver Inverted DATA out. AC Coupled	

13	RD+	Receiver Non-inverted DATA out. AC Coupled	
14	V _{EER}	Receiver Ground (Common with Transmitter Ground)	1
15	V _{CCR}	Receiver Power Supply	
16	V _{CCT}	Transmitter Power Supply	
17	V _{EET}	Transmitter Ground (Common with Receiver Ground)	1
18	TD+	Transmitter Non-Inverted DATA in. AC Coupled.	
19	TD-	Transmitter Inverted DATA in. AC Coupled.	
20	V _{EET}	Transmitter Ground (Common with Receiver Ground)	1

Notes:

1. Circuit ground is internally isolated from chassis ground.
2. Laser output disabled on T_{DIS} >2.0V or open, enabled on T_{DIS} <0.8V.
3. Should be pulled up with 4.7k - 10kohms on host board to a voltage between 2.0V and 3.6V. MOD_DEF (0) pulls line low to indicate module is plugged in.
4. This is an optional input used to control the receiver bandwidth for compatibility with multiple data rates (most likely Fiber Channel 1x and 2x Rates). If implemented, the input will be internally pulled down with > 30kΩ resistor. The input states are:
 - Low (0 – 0.8V): Reduced Bandwidth
 - (> 0.8 V < 2.0V): Undefined
 - High (2.0 – 3.465V): Full Bandwidth
 - Open: Reduced Bandwidth
5. LOS is open collector output. Should be pulled up with 4.7k - 10kohms on host board to a voltage between 2.0V and 3.6V. Logic 0 indicates normal operation; logic 1 indicates loss of signal.

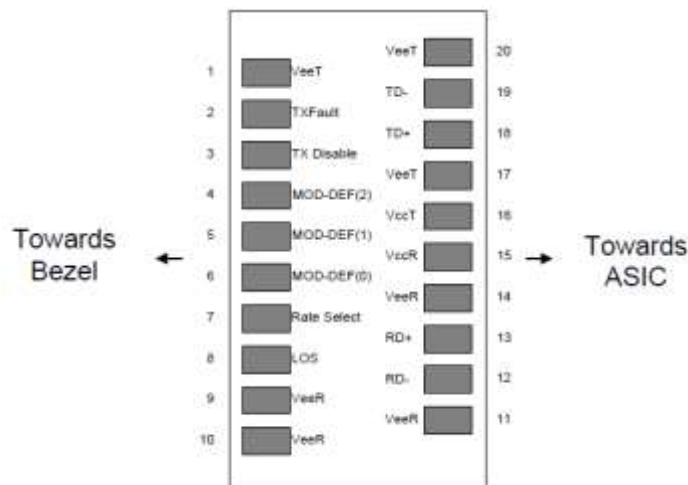

Figure 2: Pin-out of Connector Block on Host Board

II. Absolute Maximum Ratings

Parameter	Symbol	Min.	Typ.	Max.	Unit	Note
Storage Temperature	Ts	-40		85	°C	
Storage Ambient Humidity	HA	5		95	%	
Power Supply Voltage	VCC	-0.5		4	V	
Signal Input Voltage		-0.3		Vcc+0.3	V	
Receiver Damage Threshold		5			dBm	

III. Recommended Operating Conditions

Parameter	Symbol	Min.	Typ.	Max.	Unit	Note	
Case Operating Temperature	Tcase	0		70	°C	TS-SF-BL34(43)15-20	
		-10		80		TS-SF-BL34(43)15-20E	
		-40		85		TS-SF-BL34(43)15-20A	
Ambient Humidity	HA	5		70	%	Non-condensing	
Power Supply Voltage	VCC	3.13	3.3	3.47	V		
Power Supply Current	ICC			280	mA		
Power Supply Noise Rejection				100	mVp-p	100Hz to 1MHz	
Data Rate			155/1 55		Mbps	TX Rate/RX Rate	
Transmission Distance				20	KM		
Coupled Fiber	Single mode fiber						9/125um SMF

IV. Specification of Transmitter

Parameter	Symbol	Min.	Typ.	Max.	Unit	Note	
Average Output Power	P _{OUT}	-15		-8	dBm		
Extinction Ratio	ER	8.2			dB		
Center Wavelength	λ_c	1270	1310	1360	nm	TS-SF-BL34105-20	
		1470	1490	1510		TS-SF-BL4315-20	
Spectrum Width (RMS)	σ			3.5	nm	FP Laser	
Transmitter OFF Output Power	P _{off}			-45	dBm		
Differential Line Input Impedance	R _{IN}	90	100	110	Ohm		
Jitter P-P	t _r			1	ns	Note (1)	
Output Eye Mask	Compliant with G.957(class 1 laser safety)						Note (2)

Note (1): Measure at 2²³-1 NRZ PRBS pattern

Note (2): Transmitter eye mask definition

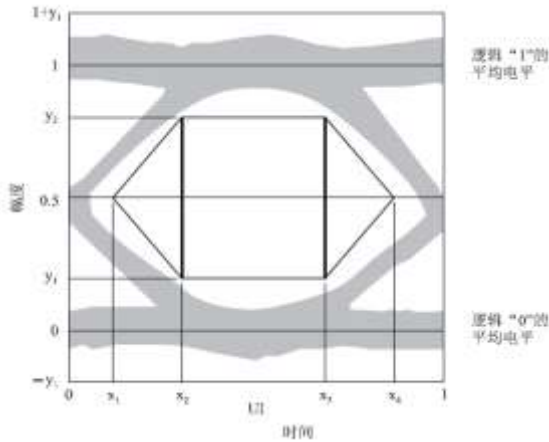

	STM-1	STM-4
x_1/x_4	0.15/0.85	0.25/0.75
x_2/x_3	0.35/0.65	0.40/0.60
y_1/y_2	0.20/0.80	0.20/0.80

V. Specification of Receiver

Parameter	Symbol	Min.	Typ.	Max.	Unit	Note
Input Optical Wavelength	λ_{IN}	1470	1490	1510	nm	TS-SF-BL3415-20
		1270	1310	1360		TS-SF-BL4315-20
Receiver Sensitivity	P_{IN}			-29	dBm	Note (1)
Input Saturation Power (Overload)	P_{SAT}	-8			dBm	
Los Of Signal Assert	P_A	-38			dBm	
Los Of Signal De-assert	P_D			-30	dBm	Note (2)
LOS Hysteresis	P_A-P_D	0.5	2	6	dB	

Note (1): Measured with Light source 1490nm (1310nm), ER=9dB; BER =10^{-12} @PRBS=2²³-1 NRZ

Note (2): When LOS de-asserted, the RX data+/- output is High-level (fixed)

VI. Electrical Interface Characteristics

Parameter	Symbol	Min.	Typ.	Max.	Unit	Note
Transmitter						
Total Supply Current	I_{CC}			A	mA	Note (1)
Transmitter Disable Input-High	V_{DISH}	2		$V_{CC}+0.3$	V	
Transmitter Disable Input-Low	V_{DISL}	0		0.8	V	
Transmitter Fault Input-High	V_{DISL}	2		$V_{CC}+0.3$	V	
Transmitter Fault Input-Low	V_{TxFH}	0		0.8	V	
Receiver						
Total Supply Current	I_{CC}			B	mA	Note (1)
LOSS Output Voltage-High	V_{LOSH}	2		$V_{CC}+0.3$	V	LVTTTL
LOSS Output Voltage-Low	V_{LOSL}	0		0.8	V	

Note (1): A (TX) + B (RX) = 280mA (Not include termination circuit)

VII. Recommend Circuit Schematic

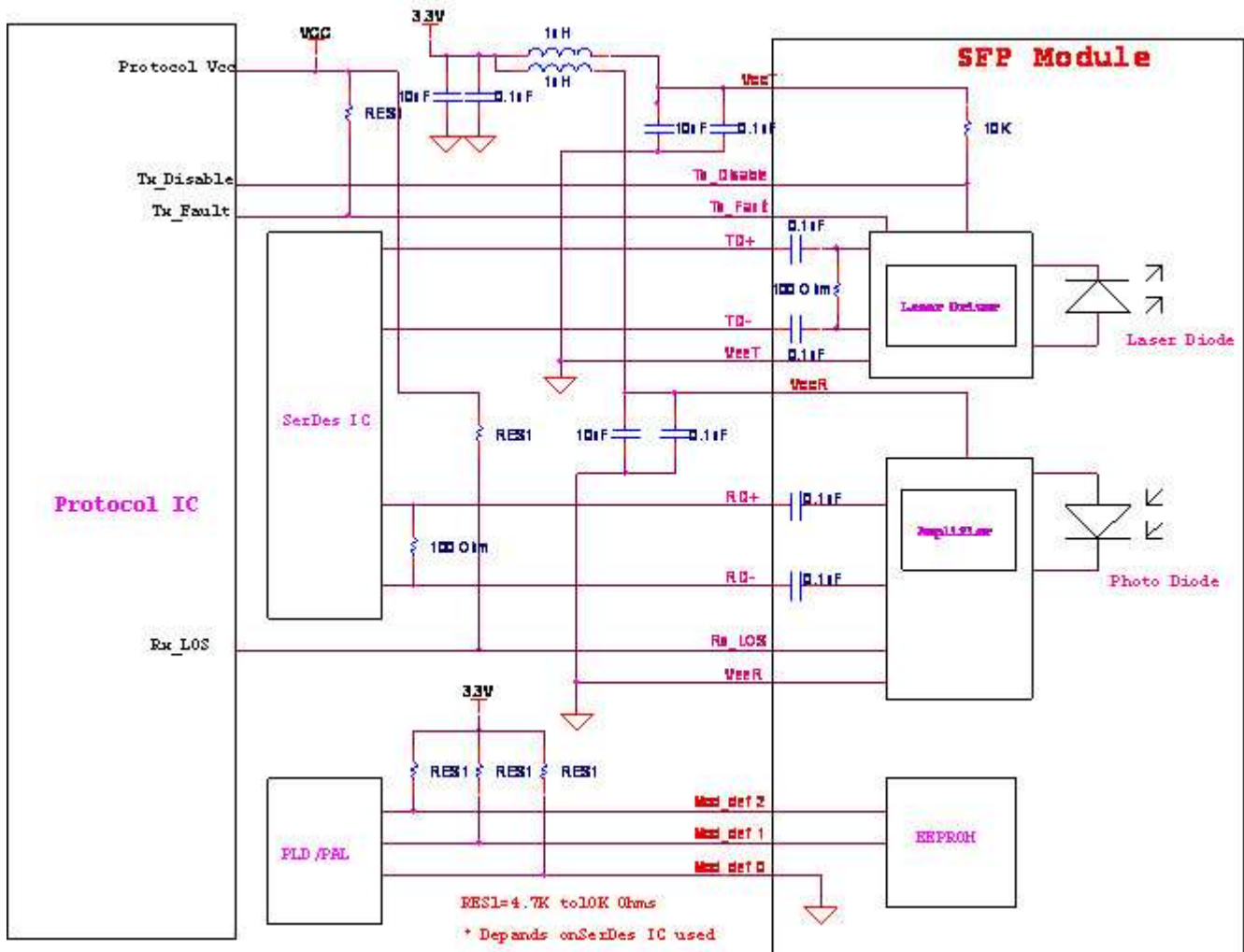

VIII. Mechanical Specifications (Unit: mm)

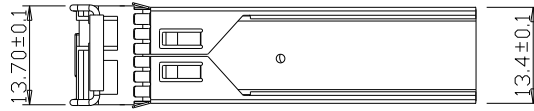

Units in mm

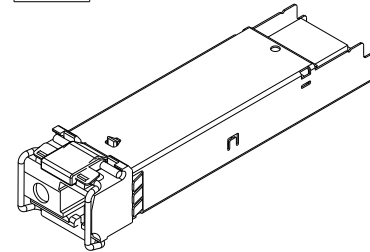
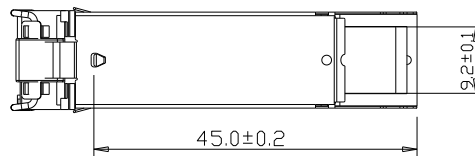
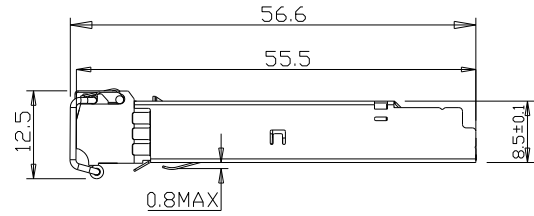

TS-SF-BL34(43)15-20

IX. Regulatory Compliance

Feature	Reference	Performance
Electrostatic discharge (ESD)	IEC/EN 61000-4-2	Compatible with standards
Electromagnetic Interference (EMI)	FCC Part 15 Class B EN 55022 Class B (CISPR 22A)	Compatible with standards
Laser Eye Safety	FDA 21CFR 1040.10, 1040.11 IEC/EN 60825-1 , 2	Class 1 laser product
Component Recognition	IEC/EN 60950 , UL	Compatible with standards
ROHS	2002/95/EC	Compatible with standards
EMC	EN61000-3	Compatible with standards

Appendix A. Document Revision

Version No.	Date	Description
1.0	2010-09-01	Preliminary datasheet
2.0	2011-09-10	Update format and company's logo