

TS-SF-BL45(54)62-80

SFP BIDI 622M 1490/1550nm(1550/1490nm) 80KM Transceiver

PRODUCT FEATURES

- Up to 622Mb/s data links

DFB laser transmitter

-
- PIN photo-detector
- Up to 80km on 9/125 μ m SMF
- Hot-pluggable SFP footprint
- BIDI LC/UPC type pluggable optical interface
- Low power dissipation
- Metal enclosure, for lower EMI
- RoHS compliant and lead-free
- Single +3.3V power supply
- Compliant with SFF-8472
- Case operating temperature

Commercial: 0 $^{\circ}$ C to +70 $^{\circ}$ C

Extended: -10 $^{\circ}$ C to +80 $^{\circ}$ C

Industrial: -40 $^{\circ}$ C to +85 $^{\circ}$ C



APPLICATIONS

- Switch to Switch Interface
- Fast Ethernet
- Switched Backplane Applications
- Router/Server Interface
- Other Optical Links



PRODUCT DESCRIPTION

TRANSCOM's TS-SF-BL45(54)62-80 Small Form Factor Pluggable (SFP) transceivers are compatible with the Small Form Factor Pluggable Multi-Sourcing Agreement (MSA), The transceiver consists of four sections: the LD driver, the limiting amplifier, the 1490nm DFB laser(the 1550nm DFB laser) and the PIN photo-detector. The module data link up to 80KM in 9/125um single mode fiber.

The optical output can be disabled by a TTL logic high-level input of Tx Disable, and the system also can disable the module via I2C. Tx Fault is provided to indicate that degradation of the laser. Loss of signal (LOS) output is provided to indicate the loss of an input optical signal of receiver or the link status with partner. The system can also get the LOS (or Link)/Disable/Fault information via I2C register access.

Ordering information

| Product part Number | Data Rate (Mbps) | Media | Wavelength (nm) | Transmission Distance(km) | Temperature Range (Tcase) (°C) | |
|----------------------|------------------|-------------------|----------------------|---------------------------|------------------------------------|------------|
| | | | | | | |
| TS-SF-BL45(54)62-80 | 622 | Single mode fiber | 1490/1550(1550/1490) | 80 | 0~70 | commercial |
| TS-SF-BL45(54)62-80E | 622 | Single mode fiber | 1490/1550(1550/1490) | 80 | -10~80 | extended |
| TS-SF-BL45(54)62-80A | 622 | Single mode fiber | 1490/1550(1550/1490) | 80 | -40~85 | industrial |

I .Pin Descriptions

| Pin | Symbol | Name/Description | Ref. |
|-----|--------------------|----------------------------------------------------------------|------|
| 1 | V _{EET} | Transmitter Ground (Common with Receiver Ground) | 1 |
| 2 | T _{FAULT} | Transmitter Fault. | |
| 3 | T _{DIS} | Transmitter Disable. Laser output disabled on high or open. | 2 |
| 4 | MOD_DEF(2) | Module Definition 2. Data line for Serial ID. | 3 |
| 5 | MOD_DEF(1) | Module Definition 1. Clock line for Serial ID. | 3 |
| 6 | MOD_DEF(0) | Module Definition 0. Grounded within the module. | 3 |
| 7 | Rate Select | No connection required | 4 |
| 8 | LOS | Loss of Signal indication. Logic 0 indicates normal operation. | 5 |
| 9 | V _{EER} | Receiver Ground (Common with Transmitter Ground) | 1 |
| 10 | V _{EER} | Receiver Ground (Common with Transmitter Ground) | 1 |
| 11 | V _{EER} | Receiver Ground (Common with Transmitter Ground) | 1 |
| 12 | RD- | Receiver Inverted DATA out. AC Coupled | |
| 13 | RD+ | Receiver Non-inverted DATA out. AC Coupled | |
| 14 | V _{EER} | Receiver Ground (Common with Transmitter Ground) | 1 |
| 15 | V _{CCR} | Receiver Power Supply | |

| | | | |
|----|------------------|--------------------------------------------------|---|
| 16 | V _{CCT} | Transmitter Power Supply | |
| 17 | V _{EET} | Transmitter Ground (Common with Receiver Ground) | 1 |
| 18 | TD+ | Transmitter Non-Inverted DATA in. AC Coupled. | |
| 19 | TD- | Transmitter Inverted DATA in. AC Coupled. | |
| 20 | V _{EET} | Transmitter Ground (Common with Receiver Ground) | 1 |

Notes:

1. Circuit ground is internally isolated from chassis ground.
2. Laser output disabled on T_{DIS} > 2.0V or open, enabled on T_{DIS} < 0.8V.
3. Should be pulled up with 4.7k - 10kohms on host board to a voltage between 2.0V and 3.6V. MOD_DEF(0) pulls line low to indicate module is plugged in.
4. This is an optional input used to control the receiver bandwidth for compatibility with multiple data rates (most likely Fiber Channel 1x and 2x Rates). If implemented, the input will be internally pulled down with > 30kΩ resistor. The input states are:
 - Low (0 – 0.8V): Reduced Bandwidth
 - (>0.8, < 2.0V): Undefined
 - High (2.0 – 3.465V): Full Bandwidth
 - Open: Reduced Bandwidth
5. LOS is open collector output. Should be pulled up with 4.7k - 10kohms on host board to a voltage between 2.0V and 3.6V. Logic 0 indicates normal operation; logic 1 indicates loss of signal.

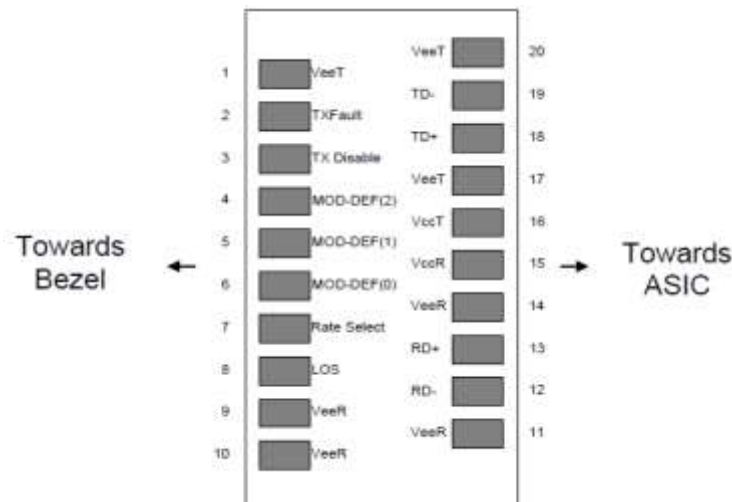

Figure 2: Pin-out of Connector Block on Host Board

II. Absolute Maximum Ratings

| Parameter | Symbol | Min. | Typ. | Max. | Unit | Note |
|---------------------------|--------|------|------|---------|------|------|
| Storage Temperature | Ts | -40 | | 85 | ℃ | |
| Storage Ambient Humidity | HA | 5 | | 95 | % | |
| Power Supply Voltage | VCC | -0.5 | | 4 | V | |
| Signal Input Voltage | | -0.3 | | Vcc+0.3 | V | |
| Receiver Damage Threshold | | +6 | | | dBm | |

III.

Recommended Operating Conditions

| Parameter | Symbol | Min. | Typ. | Max. | Unit | Note | |
|------------------------------|--------|-------------------|---------|------|-------|----------------------|-------------|
| Case Operating Temperature | Tcase | 0 | | 70 | ℃ | TS-SF-BL45(54)62-80 | |
| | | -10 | | 80 | | TS-SF-BL45(54)62-80E | |
| | | -40 | | 85 | | TS-SF-BL45(54)62-80A | |
| Ambient Humidity | HA | 5 | | 70 | % | Non-condensing | |
| Power Supply Voltage | VCC | 3.13 | 3.3 | 3.47 | V | | |
| Power Supply Current | ICC | | | 300 | mA | | |
| Power Supply Noise Rejection | | | | 100 | mVp-p | 100Hz to 1MHz | |
| Data Rate | | | 622/622 | | Mbps | TX Rate/RX Rate | |
| Transmission Distance | | | | 80 | KM | | |
| Coupled Fiber | | Single mode fiber | | | | | 9/125um SMF |

IV. Specification of Transmitter

| Parameter | Symbol | Min. | Typ. | Max. | Unit | Note | |
|-----------------------------------|------------------|------------------------------------------------|------|------|------|-----------------|----------|
| Average Output Power | P _{OUT} | -3 | | 2 | dBm | | |
| Extinction Ratio | ER | 8.2 | | | dB | | |
| Center Wavelength | λ_c | 1470 | 1490 | 1510 | nm | TS-SF-BL4562-80 | |
| | | 1530 | 1550 | 1570 | | TS-SF-BL5462-80 | |
| Side Mode Suppression Ratio | SMSR | 30 | | | dB | DFB Laser | |
| Spectrum Bandwidth(-20dB) | σ | | | 1 | nm | | |
| Transmitter OFF Output Power | P _{OFF} | | | -45 | dBm | | |
| Differential Line Input Impedance | RIN | 90 | 100 | 110 | Ohm | | |
| Total Jitter (Peak-Peak) | t _J | | | 1 | ns | Note (1) | |
| Output Eye Mask | | Compliant with G.957 (class 1 laser safety) | | | | | Note (2) |

Note (1): Measure at 2²³-1 NRZ PRBS pattern

Note (2): Transmitter eye mask definition

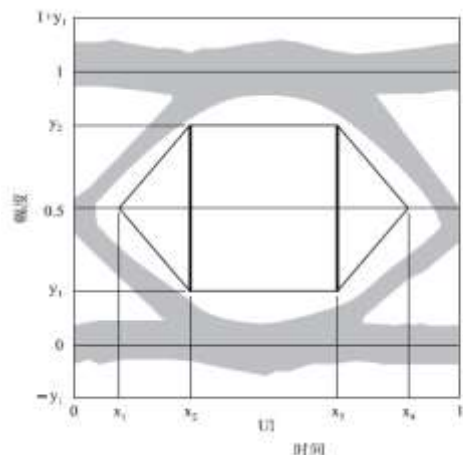

| | STM-1 | STM-4 |
|-----------|-----------|-----------|
| x_1/x_4 | 0.15/0.85 | 0.25/0.75 |
| x_2/x_3 | 0.35/0.65 | 0.40/0.60 |
| y_1/y_2 | 0.20/0.80 | 0.20/0.80 |

V. Specification of Receiver

| Parameter | Symbol | Min. | Typ. | Max. | Unit | Note |
|-----------------------------------|----------------|------|------|------|------|-----------------|
| Input Optical Wavelength | λ_{IN} | 1530 | 1550 | 1570 | nm | TS-SF-BL4562-80 |
| | | 1470 | 1490 | 1510 | | TS-SF-BL5462-80 |
| Receiver Sensitivity | P_{IN} | | | -29 | dBm | Note (1) |
| Input Saturation Power (Overload) | P_{SAT} | -8 | | | dBm | |
| Los Of Signal Assert | P_A | | | -30 | dBm | |
| Los Of Signal De-assert | P_D | -40 | | | dBm | Note (2) |
| LOS Hysteresis | P_A-P_D | 0.5 | 2 | 6 | dB | |

Note (1): Measured with Light source 1550nm(1490nm), ER=9dB; BER = 10^{-12} @PRBS=2²³-1 NRZ

Note (2): When LOS de-asserted, the RX data+/- output is High-level (fixed)

VI. Electrical Interface Characteristics

| Parameter | Symbol | Min. | Typ. | Max. | Unit | Note |
|--------------------------------|------------|------|------|--------------|------|----------|
| Transmitter | | | | | | |
| Total Supply Current | I_{CC} | | | A | mA | Note (1) |
| Transmitter Disable Input-High | V_{DISH} | 2 | | $V_{CC}+0.3$ | V | |
| Transmitter Disable Input-Low | V_{DISL} | 0 | | 0.8 | V | |
| Transmitter Fault Input-High | V_{DISL} | 2 | | $V_{CC}+0.3$ | V | |
| Transmitter Fault Input-Low | V_{TxFH} | 0 | | 0.8 | V | |
| Receiver | | | | | | |
| Total Supply Current | I_{CC} | | | B | mA | Note (1) |
| LOSS Output Voltage-High | V_{LOSH} | 2 | | $V_{CC}+0.3$ | V | LVTTTL |
| LOSS Output Voltage-Low | V_{LOSL} | 0 | | 0.8 | V | |

Note (1): A (TX) + B (RX) = 300mA (Not include termination circuit)

VII. Recommend Circuit Schematic

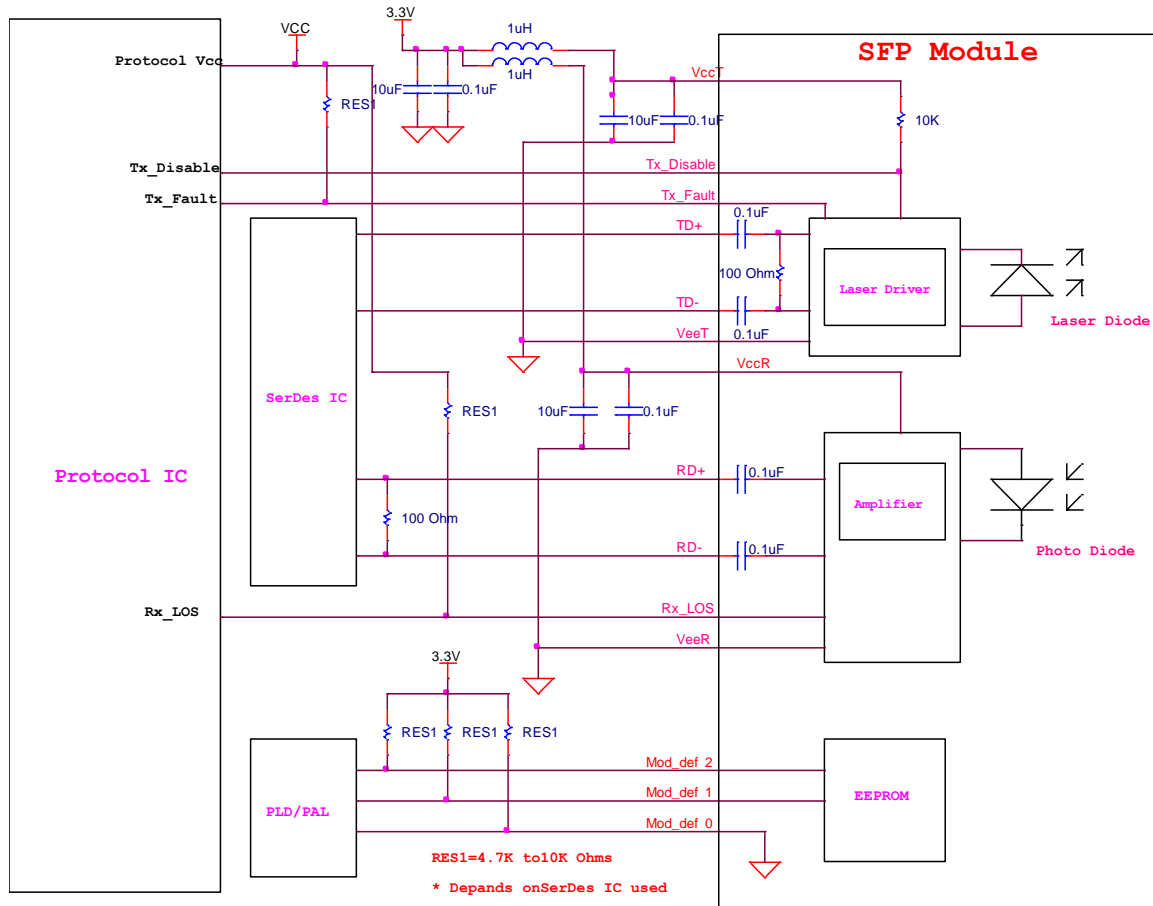

VIII. Mechanical Specifications (Unit: mm)

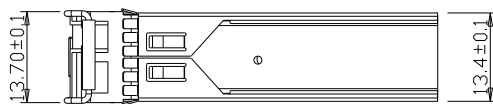

Units in mm

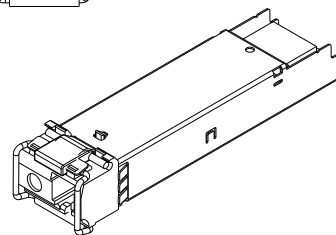
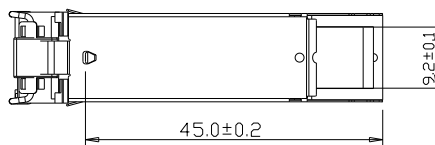
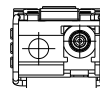
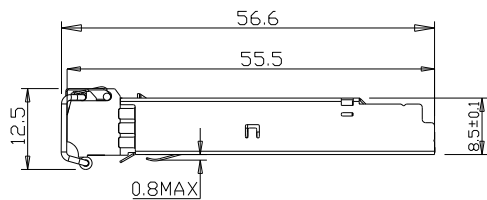

TS-SF-BL45(54)62-80



IX. Regulatory Compliance

| Feature | Reference | Performance |
|------------------------------------|-----------------------------------------------------|---------------------------|
| Electrostatic discharge (ESD) | IEC/EN 61000-4-2 | Compatible with standards |
| Electromagnetic Interference (EMI) | FCC Part 15 Class B EN 55022 Class B (CISPR 22A) | Compatible with standards |
| Laser Eye Safety | FDA 21CFR 1040.10, 1040.11 IEC/EN 60825-1 , 2 | Class 1 laser product |
| Component Recognition | IEC/EN 60950 , UL | Compatible with standards |
| ROHS | 2002/95/EC | Compatible with standards |
| EMC | EN61000-3 | Compatible with standards |

Appendix A. Document Revision

| Version No. | Date | Description |
|-------------|------------|----------------------------------|
| 1.0 | 2010-09-01 | Preliminary datasheet |
| 2.0 | 2011-09-10 | Update format and company's logo |